

Composeal Shower Pan

40 MIL

WATERPROOF MEMBRANE

GREY PVC SHOWER PAN MEMBRANE

FOR WATERPROOFING UNDER 'THICK BED'
TILE INSTALLATIONS ♦ PROTECTS FROM
COSTLY SECONDARY WATER DAMAGE

- ◆ Flexible Waterproofing for Floors & Walls
- ◆ Custom Tiled Showers, Baths, Fountains, Roof Decks, Terraces, Exterior Stairs & Walkways
- ◆ Can Be Easily Formed to Fit Any Dimensions or Drain Locations
- ◆ Durable and Long Lasting
- ◆ Ideal for New Construction & Renovations
- ◆ Other Composeal Shower Pan installation products include: Large Format Inside & Outside Corners • Weld-Tite Flexible Vinyl Cement (available 1/4 & 1 pint) • Polyseal Adhesive & Sealant

COMPOSEAL GREY

- ◆ Economically Priced
- ◆ 50% Recycled Content 
- ◆ Manufactured in 40 mil Thicknesses
- ◆ Available in 5 & 6 Foot Widths
- ◆ 100 Foot Rolls

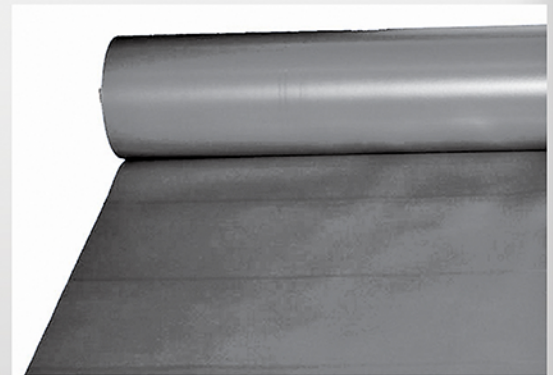

COMPOSEAL GREY meets and surpasses **ASTM D4551**
for PVC flexible waterproofing membrane



800-221-1056 www.compotite.com 2556 W. Commerce St. Dallas, TX 75212



The NEW Company You've Known For Over 75 Years



Compositite Corporation, headquartered in Los Angeles, CA has been manufacturing shower pans since 1938. Compositite®, the first and original standard for shower pan liners, was superseded by COMPOSEAL in 1979, which was developed to provide even greater protection, ease of handling and long term durability.

◆ STANDARD SHOWER PAN INSTALLATION

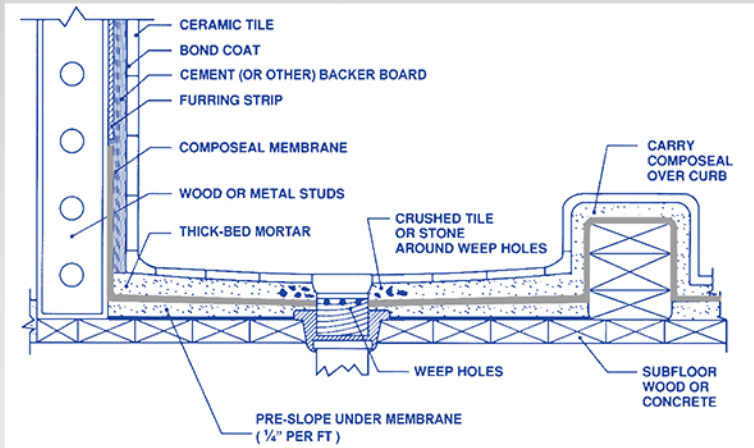

Figure 1 TCNA Assembly B414

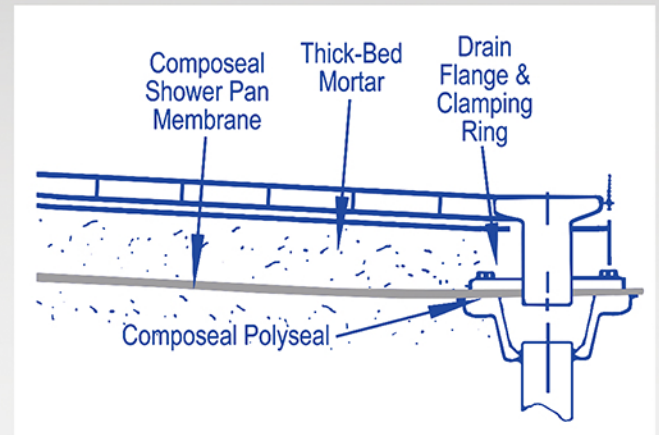

Figure 2 TCNA Assembly B415

Before placing pan, see that the sub-floor is sloped toward drain $\frac{1}{4}$ " per foot using cement mortar if necessary, and is free of loose objects or projections such as nail heads or gravel.

Make turn-up along walls not less than 3" above curb line, allowing sufficient material to fasten to outside face of curb and out onto floor a few inches away from shower if possible. If there is no curb in the shower, materials should be fastened 6" above the floor.

Notch wood studs to $\frac{1}{2}$ " to the height of the pan to allow COMPOSEAL to be flush with face of the studs. For metal studs, use furring strips ($\frac{1}{4}$ " to $\frac{1}{2}$ " above the top of the pan).

Fasten 3" or higher above the top of curb. Use flathead roofing nails or staples on wood studs. Use drywall screws and washers on metal studs.

DO NOT penetrate the membrane anywhere below the 3" mark in order to maintain waterproof integrity of the pan.

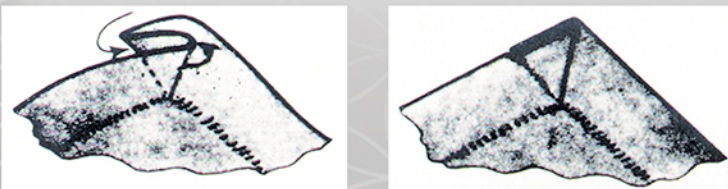

Figure 3

Fold corners outside pan as illustrated (Figure 3). Allow for plumb surface by turning corner folds of pan out of the way between studs. Notch studs or use furring strips mentioned above to maintain a flush surface. **DO NOT cut pan corners.**

Use bolt-down clamping-ring type drain with weep-holes. Set so sub-drain lip is flush with subfloor. Trim opening for drain exactly to the size of drain opening and **NOT** out to bolt holes. Pierce membrane at the bolt holes with

a nail or the like to accommodate bolts with a tight fit. Use Compotite Polyseal or a 100% mold/mildew resistant silicone to bond the pan and sub-drain.

Plug sub-drain and fill pan with water and let stand for 24 hours to insure clamping ring is tight and pan undamaged. Bolt clamping ring firmly. Place a small amount of pea gravel or other porous material at weep holes so they remain clear when setting bed is poured.

◆ ACCESSORY INSTALLATION MATERIALS

SEAM WELDING

COMPOSEAL GREY sheets can be welded together to create a perfect waterproof bond with instant contact strength using Weld-Tite by Compotite Flexible Vinyl Cement. Use only Compotite approved PVC cement for seaming and welding Composeal. Lay sheets with an overlap of two inches with upper lap edge toward direction of watershed. Fold back top edge and apply Weld-Tite by Compotite Flexible Vinyl Cement to both surfaces. Once the surfaces have become slightly tacky place together and press or roll to form a tight bond. Always verify complete adhesion of the layers.



CORNERS & CURB PROTECTORS

COMPOSEAL's multi-purpose, preformed corners/curb protectors are available to reinforce waterproofing at all corners and curbs. Use the Weld-Tite by Compotite Flexible Vinyl Cement. These protectors are sold in pairs and can be used for all outside corners as shown in (Figure 4). Inside corners are available but Compotite DOES NOT recommend using them for most installations. When inside corners are cut they weaken the installation.

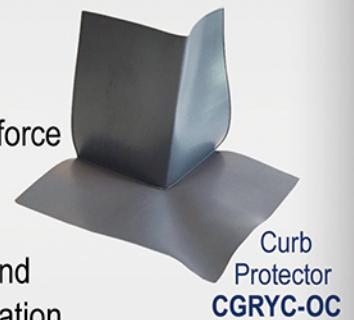
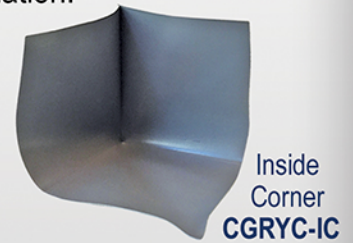

Figure 4
COMPOSEAL GREY
corners



SEALANT

COMPOSEAL GREY is bonded to the sub-drain assembly using Composeal Polyseal

Composeal Polyseal
CPS-10-S



◆ ADDITIONAL WATERPROOFING INSTALLATIONS

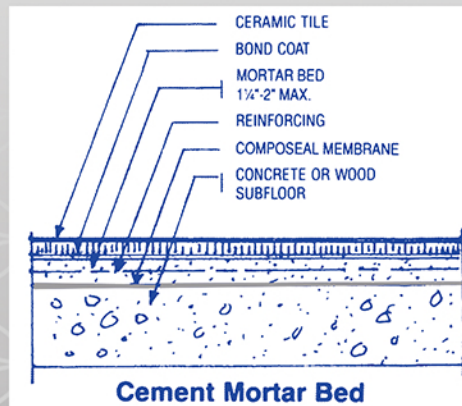

Figure 5

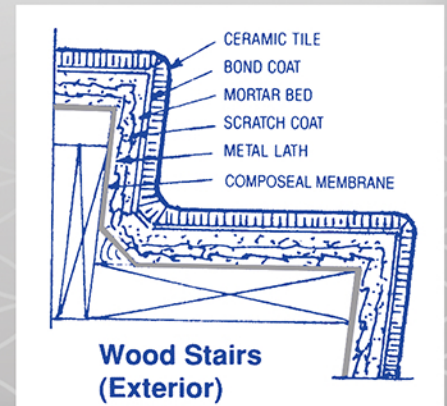

Figure 6

◆ SPECIFICATIONS & CODES:

COMPOSEAL GREY complies with the standards of ICC-ES for the USA and Canada (report PMG-1459) and and NES (PCR SP 102). COMPOSEAL GREY has separate municipal approval where required, City of Los Angeles (RR#4398), City of Philadelphia (40 mil), Metropolitan Dade County, Florida and The Commonwealth of Massachusetts. Approval is no longer required in New York City for concealed PVC waterproof membrane.

COMPOSEAL GREY also complies with the Corps of Engineers specs for PVC shower pan material (para 5.8.3.2 15 p1-18) and meets the requirements of FHA Publication 4900.1.

COMPOSEAL GREY meets and surpasses the engineering requirements of the American Society for Testing and Materials (ASTM). ASTM D4551 is the test standard established for PVC membranes used for Shower Pans.

ENGINEERING PROPERTIES	ASTM D 4551 Specifications	COMPOSEAL Test Results
	Grade 40	40 mil
Thickness, inches	.040"	.042"
Tensile Strength, lbs/in. width	80-lb min.	113-lb (2700 psi)
Tensile Strength at 100% elongation	40-lb min.	57-lb
Ultimate Elongation before breaking	300% min.	400% +
Tear Resistance, lbs/in. width	250-lb min.	263-lb
Pinholes	None	None
Micro-Organism Resistance (fungus, mildew, mold)	No Growth	No Growth
Chemical Resistance:		
Distilled H ₂ O % wt. change*	1% max	+0.4%
Soapy H ₂ O % wt. change*	2% max	+0.3%
Alkali, pass/fail (hydrostatic)	Pass	Pass
Shrinkage, dimension change at 158° F ASTM 1204	5% max	2.9%
Volatility, % loss at 158° F after aging	1.5 max	None
Hydrostatic Pressure (to test water penetration):		
Original Condition	Pass	Pass
After Folding Test (cold crack, 4 hrs. @ 0° F)	Pass	Pass
After Puncture Test	Pass	Pass
After Indentation Test	Pass	Pass
No evidence of surface wetness or other signs of water penetration was detected on any of the tested specimens.		
Additional Tests:	ASTM D751	COMPOSEAL 40
Seam (lap joint) strength ASTM D751	8 lbs/in. min.	85 lbs/inch
Specific Gravity: 1.29 g/cm ³		
Cold Crack: passed @ -53° F		
ASTM Standards D1004, D 2240, D 412, D1790, E 96 and FHA Spec. 4900.1 are also met by COMPOSEAL.		
*Measure of water/chemical surface absorption.		

Tests were conducted by the SGS U.S. Testing Co., Tulsa, OK 74116 & Smith Emery Co., Test No. T-88-122A-B.

◆ LIMITATIONS:

COMPOSEAL GREY should not be used as a liner for pools containing fish or water plants

◆ WARRANTY:

COMPOSEAL GREY is warranted against failure for any reason, and in the case of the event of failure, replacement material will be supplied at no charge. This warranty applies only to the membrane itself and not to the manner of installation over which we have no control. It does not extend to consequential damage or other implied responsibility. COMPOSEAL GREY should last the life of the building.

◆ TECHNICAL SUPPORT:

The TCNA (Tile Council of North America) Handbook for Ceramic, Glass and Stone Tile Installation provides general instructions and guidelines for installations requiring waterproof membranes. Compotite Corporation provides technical support for installers of COMPOSEAL products. Refer to our website at www.compotite.com or call our main office at **800-221-1056** for additional technical literature and installation materials. COMPOSEAL GREY and its accessory products are available through quality ceramic tile distributors and plumbing supply houses. For information about your local Compotite Representative call **800-221-1056** or consult our website at www.compotite.com.